



Natural Daylight Design Through Rooflighting,

Amendments 2009.

narm

National Association of Rooflight Manufacturers

Introduction

The National Association of Rooflight Manufacturers (NARM) represents a complete cross section of rooflight design and material type manufactured in the UK, and together with their Associate Members, they are able to provide a knowledge base second to none on all matters relating to providing good quality natural daylight into all non-domestic buildings.

Daylight design will be influenced by the building size and its usage. For smaller buildings vertical glazing will generally be adequate but only for areas within 6m of a window. For larger buildings, rooflighting or a combination of both roof and wall glazing will be needed.

The manufacturers within NARM offer a complete range of product and material types including in-plane profiled rooflights, continuous barrel vaults, modular domes and pyramids, panel glazing systems and architectural glazing systems for skylights, lantern lights and atria.

There are three principle types of material used to provide natural light into buildings:

Glass

Used widely in large span rooflights such as atria, this readily recycled glazing media benefits from the low cost availability of low emissivity coatings and improved cavities such as argon gas filled. Very low U-values are therefore simply achieved with the same glazing systems and depth of sections without the need for triple glazing.

GRP (Glass Reinforced Polyester)

A translucent thermoset material under the general heading of plastic that once formed into the required shape can never be reshaped after curing. A very tough and durable material that in opaque format is used for yacht hulls, aircraft nose cones and minesweeper hulls.

Polycarbonate and Other Thermoplastics

Polycarbonate is a clear thermoplastic formed under heat and fixed in shape by cooling. It can be recycled by reheating to a liquid state. When correctly processed and handled it can provide excellent impact resistance and good resistance to UV and weathering.

Other thermoplastics include PVC that is largely used in DIY and agricultural markets, but rarely in industrial or commercial applications due to its fragility. Acrylic has good UV resistance but is not used in the UK as it does not meet the required standards for either impact or fire resistance.

Natural Daylight is a vital element in our daily life. The general pattern of life for humans is to sleep at night and work and play during the daylight hours. Our brain functions and responds to the stimulus of daylight. Providing natural daylight into the working environment is of fundamental importance for the well being, efficiency and safety for the people in that environment. The electric light bulb is a poor substitute to the fulfillment of the human requirements.

This document demonstrates how natural daylighting can best be incorporated into the building design. It looks at the various material options, giving their advantages and limitations, highlighting fixing needs, durability requirements and legislation issues.

Many of the members of this Association have been making rooflights since the 1950s and 1960s and have a wealth of knowledge that is available to be tapped. The Association's aim is to impart their knowledge to designers and contractors to achieve excellent natural daylight design in buildings, so that people who work in them or who visit them have that feel good factor.

Daylight Design

Daylight Design

Daylight is a vital natural resource that will significantly improve the environment within any building. Rooflights provide three times more light than the same area of vertical glazing. They can also provide a much more even distribution of light, particularly in larger structures. Where vertical glazing exists, the effective area for natural lighting will only be within 6m of the wall containing the window. These facts are well understood by most people involved in building design. However the huge potential of rooflights to provide exactly the amount, type and distribution of natural light required to meet any given specification is not always appreciated. Rooflights can help to provide natural light with qualities appropriate to the use of the building.

Benefits of Natural Daylight

Daylight is an essential natural asset. For those of us living in temperate Northern climates, the beneficial effect of sunlight is easy to recognise; a couple of sunny days seem to lift everyone's spirits. Research also shows that suicide rates are considerably higher in parts of the world where daylight is very limited for significant parts of the year. On a slightly less dramatic but equally significant level, there is also a growing body of evidence to suggest that buildings enjoying high levels of natural light are literally more successful than those more reliant on artificial light. In all environments the eye and brain functions respond better to natural light, so people perform better, while passive solar gain can reduce energy costs.

Education

Research demonstrates a clear correlation between classrooms with good natural light and improved student performance and even attendance. This is because in natural light children concentrate better so are more focused and less easily distracted. Some studies suggest that health is also enhanced helping to explain the improved attendance.

Health

In the UK we are used to hearing of SAD, Seasonal Affective Disorder, a clinically diagnosed condition in which the lack of sunlight in winter makes people feel ill. Natural light helps people to feel better but it can also aid the healing process. In hospitals, studies have proven that the recovery rate of patients is accelerated where levels of natural light are increased.

Business

Daylight improves concentration so that working environments, be they factories or offices with natural light, tend to achieve increased productivity. Research into retail environments suggests that in many situations sales tend to be better in naturally lit locations; colours are more vivid and true, making goods appear attractive and encouraging customers to spend more time in these areas. A number of the UK's leading retail organizations include large areas of rooflights in specifications for all new build projects to ensure a high percentage of evenly distributed natural light within the interior.

Recreation

People like bright naturally lit environments, evidenced by the huge popularity of domestic conservatories and sunrooms. It is therefore logical that in their leisure time people prefer facilities enjoying high levels of daylight. Most sporting and recreational facilities today try to maximise natural daylight in recognition of this.

Legal Requirements

The Building Regulations Part L 2006 not only considers the fabric of the building elements but also the energy consumption and efficiency of all the mechanical services such as boilers, hot water and artificial

lighting. The total energy requirement of a building is calculated with government approved National Calculation Tool software such as SBEM (Simplified Building Energy Model). The appropriate rooflight specification and area parameters may be loaded into SBEM which then uses the data as part of the overall building calculation. Independent research proves that an appropriate use of rooflighting, usually 15 to 20% of the roof area, coupled with well designed controlled artificial lighting, will assist in reducing the carbon footprint of a building when considered under Building Regulations Part L 2006, see Section 4 - Legal Requirements - Thermal Performance.

Energy Efficiency

Independent research proves conclusively that rooflights can save energy in many applications, and the greater the rooflight area the greater the potential savings. The amount of energy needed to light a building artificially is often much greater than the amount of energy used to heat it, and is often the greatest single energy use in operating the building. When used in conjunction with automatic lighting controls to turn the electric lights down, or off, then rooflights can have a major impact on the overall energy consumption of a building, cutting energy costs by reducing the need for use of the electric lights. Rooflights are usually less well insulated than the surrounding opaque areas of the roof, but have very little effect on the total energy required for heating, as the beneficial effects of passive solar gain compensates for the poorer insulation. Electricity used for lighting is much more expensive in terms of CO₂ than gas used for heating, so that including large areas of rooflights is one of the single most effective ways of improving the environment. Using rooflights to provide a bright, naturally lit interior will save money, provide a more pleasant environment people want to spend time in and contribute to the government's target to reduce emissions of CO₂.

Type of Light

Rooflights are not only the most effective way of allowing natural light into a building; they can also determine the type and amount of light entering the building.

Direct or Diffused

Direct Light - As the name suggests light passes through the rooflight without any disruption or interference, entering the structure as a straight beam. It therefore gives strong light in a given area but less general light in the surrounding area. It is useful where strong light is required in an area for close detailed work such as painting, or in situations where a very natural environment is desired, or the designer wants people in the building to see the sky through the roof. Direct light will result in shadows and glare on sunnier days.

Polycarbonate, PVC and glass in clear and most tinted options provide direct light.

Diffused Light - As the light passes through the rooflight it is scattered giving a much more even distribution of light into the structure below. It is useful when the requirement is for ambient lighting over a large area with minimal shadows. Most industrial, commercial and sporting facilities prefer diffused light for these qualities.

GRP in all forms, solid and multi-wall polycarbonate, PVC, and glass in patterned and opal tinted forms all provide diffused light.

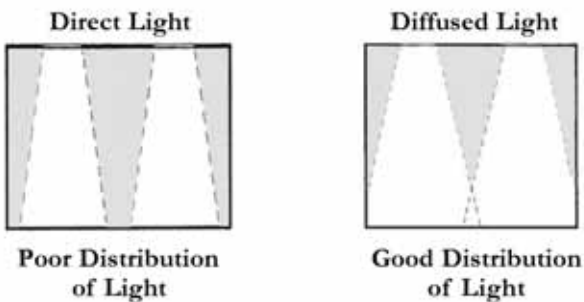

Amount of Light

Different materials and different tints of materials provide varying amounts of light into the building. In clear format most single skin rooflight materials will have a light transmission of 80%-90%. This must however be checked for the specific rooflight being used; material thickness, diffusing or colour tints, and number of skins can all affect overall light transmission. In some situations the amount of light entering the building needs to be controlled, usually to prevent overheating. Tinted materials will limit the light entering the building. It is impossible to give a general guide to the light transmission achieved through the various tinted options available, as these vary not only from material to material but also from manufacturer to manufacturer.

Daylighting

Workplace (Health Safety and Welfare) Regulations 1992 state, "Every workplace shall have suitable and sufficient lighting which shall, so far as is reasonably practicable, be by natural light". These comments are restated in HSG 38 – Lighting at Work.

The most effective method of providing even, consistent daylight particularly in large buildings, is through rooflighting – up to three times more efficient than windows of similar area. Diffusing materials should be used wherever possible to provide even light distribution and avoid glare. Wall glazing is less effective and can create internal shadows and dark corners. However it does offer good psychological benefits and must not be ignored.

Rooflight Areas to Achieve Adequate Natural Lighting

Rooflights make a positive contribution to the internal environment in a building, but also reduce energy use and cost, and contribute to the external environment by reducing the carbon footprint, helping to meet the requirements of Part L Building Regulations. The greater the rooflight area, the bigger the contribution the rooflights can make.

Rooflight area should be between 15% and 20% of the roof

Research demonstrates that installing between 15%-20% rooflights can greatly reduce a building's CO₂ emissions. Installing from between 15% to 20% of the roof area in rooflights is a practical solution to ensure the lighting levels within the building are adequate and, together with automatic control of electric lighting, delivers considerable reduction in a building's energy requirement, and hence reduces CO₂ emissions. The notional building used in Part L Building Regulations assumes 20% roof area in rooflights and research demonstrates that installing less than this amount will make compliance more difficult.

Independent research

The De Montfort University's Institute of Energy and Sustainable Development is a leading authority on energy use and it has undertaken considerable research into the effect rooflights have on a building's energy consumption. This graph, generated from De Montfort University research, shows how CO₂ emissions vary with rooflight area and with different lighting requirements and occupancy patterns.

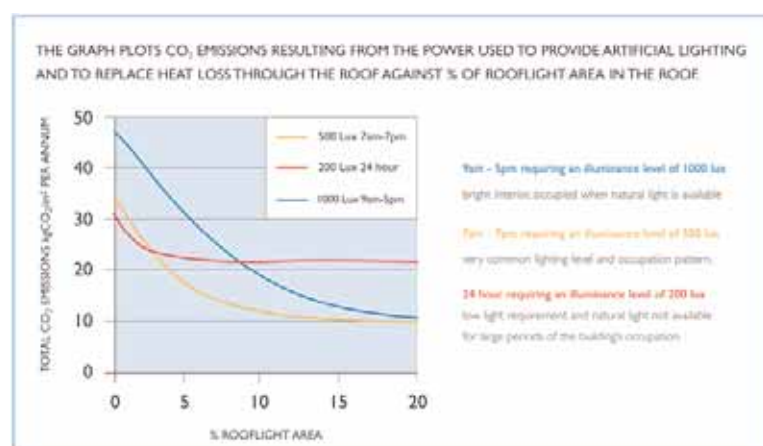

In every case adding rooflights provides very significant savings. The size of the saving depends on how much light is required inside the building and how many hours per day the building is occupied. The savings are greatest for buildings needing a bright interior during daytime occupancy.

Interior lighting levels

It is important that designers also consider possible future change of use of a building when determining rooflight area, and ensure that daylight levels are sufficient for all likely future uses. A rooflight area of 15% - 20% will provide adequate natural light for most buildings. Light is measured in lux; Table A below shows the light level required for different activities.

Table A: Examples of internal light level required for various activities

Characteristics of Activity/Interior	Level of Illuminance required (Lux)	Typical building
Continuously occupied interiors, with visual tasks not requiring perception of detail	200	Some warehousing and stores Reception spaces
Moderately difficult visual tasks	500	General retails General manufacturing areas
Difficult visual tasks requiring accurate colour judgement or perception of movement	1000	Clothing and furniture retail Sports halls
Precise detailed work requiring accurate perception of intricate detail	2000	Engineering Facilities Craft and design studios (Good background lighting plus specialist task lighting)

For manufacturing environments (and office spaces), the tasks being illuminated are usually in a horizontal plane, viewed from above, and it is usually more appropriate to measure light levels horizontally. For some applications (e.g. storage facilities and racking), the illumination of vertical surfaces may be more relevant, and light levels should then be analysed vertically. Note that inside any given building, the vertical illuminance levels are generally lower than horizontal - but lower light levels are often acceptable for tasks viewed vertically (such as storage facilities).

The possible shading effects of large obstructions inside the building should also be considered, as should rooflight layout to minimise this effect. The De Montfort University research has predicted the daylight levels in the horizontal and vertical planes inside typical large span buildings (assuming even rooflight layout, without any significant obstructions) using the latest computer modeling techniques.

This research does not define a definitive rooflight area for a particular application. Selection of exact rooflight area depends on the level of natural lighting desired, the percentage of a working year that lower natural light levels are acceptable, and the level of use of auxiliary lighting which is acceptable; these are more subjective, and should be determined by the building designer.

The research provides data on how often during a year rooflights of various area will provide any selected lighting level (and hence how often auxiliary lighting may be required). In general, if relatively small increases in rooflight area result in significant reduction in time that auxiliary lighting is required, they should be seriously considered; conversely, reductions in rooflight area can be justified where they do not result in significant increases in the time that auxiliary lighting is required. Tables B and C taken from this research, provide recommendations for rooflight area to achieve desired lighting levels, on this basis, assuming overall light transmission of 67%; for rooflights with lower or higher light transmission, the figures should be adjusted accordingly.

Table B: Recommended minimum rooflight area for desired illuminance level (horizontal)

Illuminance level required in the horizontal plane (Lux)	Recommended min rooflight area (% of floor area)
100	10
200	10
300	13
500	15
750	17
1000+	20

Table C: Recommended minimum rooflight area for desired illuminance level (vertical)

Illuminance Level Required in the Vertical Plane (Lux)	Recommended Min Rooflight Area (% of Floor Area)
100	10
200	14
300	17
500+	20

Artificial Lighting Controls

Designers need to recognise that artificial lighting will be essential during parts of the working day and particularly in the winter months, and specifically in working areas where light levels need to remain constant. In order to minimize the use of artificial lighting, thereby maximising the energy savings from natural daylight, artificial lighting should be, wherever possible controlled by automatic means that operate on "need" requirement. Designers need to bear in mind these key points: -

- The electric light is carbon inefficient in that power from the National Grid is largely generated from burning fossil fuels at modest generation efficiencies
- Where natural daylight levels are low, without lighting control, the lights in the work place get turned on in the morning and stay on all day, regardless of the need for them
- Natural daylight through rooflights is completely free, provides some useful solar gain and makes the work place a pleasant environment

The De Montfort University work highlights the importance of appropriate lighting controls to maximise the benefits of natural light via rooflights. The use of on/off photo-electric cells and proportional lighting controls will save considerably on energy usage. The options that are available should be obtained from a good artificial lighting specialist.

Solar overheating

The De Montfort University research shows in a large volume building, with evenly distributed rooflights and moderate internal heat gains a rooflight area up to 20% will not cause solar overheating.

Rooflight Construction, Configuration and Material Type

Rooflight Construction

There is a wide range of metal and fibre cement roof cladding systems and flat roof membrane systems in the market. The type of system, building design and usage will influence the choice of rooflight.

Rooflights are very effective options for delivering natural daylight deep into the interior areas of industrial, commercial, recreational and agricultural buildings.

In its simplest form the rooflight is made to the same profile shape as the metal or fibre cement sheet, and simply replaces the opaque sheet as an in plane rooflight. In some cases the metal sheet design is not ideal to replicate in rooflight material, and a better solution is to raise the rooflights out of plane from the rest of the roof. For all flat roof systems, out of plane rooflights will be the norm.

It should be noted that single and double skin rooflights do not comply with the requirements of the Part L Building Regulations. Single skin rooflights are suitable for applications such as canopies or covered walkways and double skin rooflights may be used on buildings that are exempt from Building Regulations such as agricultural or unheated buildings.

In Plane Rooflights

1. Single Skin Rooflight



2. Site Assembled Double Skin Rooflight

This type of construction consists generally of a shallow profiled rooflight sheet to match the metal liner, a spacer system, perimeter closure and an outer rooflight sheet matching the metal weather sheet. This fully compliments the assembly of the metal roof.

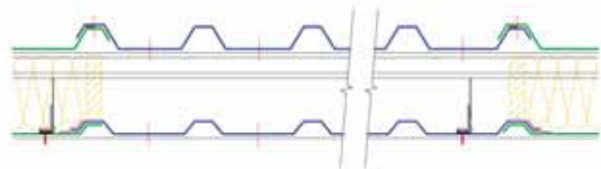

3. Site Assembled Triple Skin Rooflight

A typical assembly of three site assembled rooflight sheets, where the internal sheet could be replaced with a transparent insulation core.

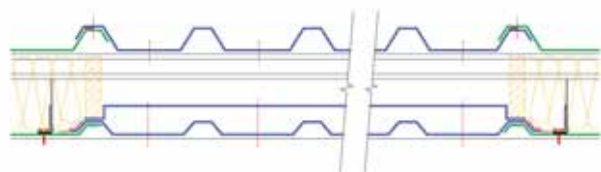

4. Factory Assembled Double Skin Rooflight

A factory made and assembled unit using purpose designed box assembly of rooflight sheeting. It incorporates a rigid spacer at the purlin line to provide a secure fixing assembly. The units are designed to match and compliment metal composite panels.

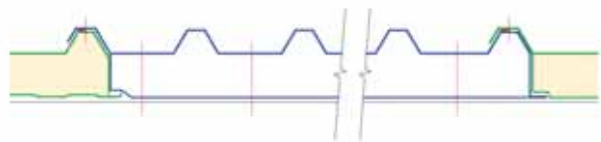

5. Factory Assembled Triple and Multi Skin and Insulated Core Assembly

A typical unit of outer skin and lining panel to match the metal composite, with one or multiple layer or transparent insulation internal to the box, of various designs to provide the requisite U-value.

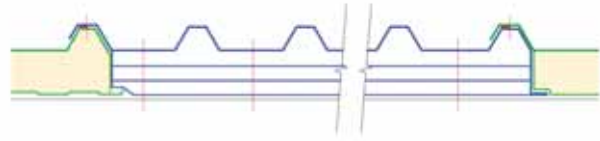

Out of Plane Rooflights

6a. Dome Rooflight

A dome or pyramid in double or triple skin format manufactured from standard sizes, but can also be purpose made to suit existing upstand dimensions.

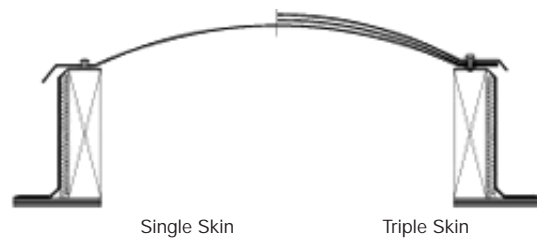

6b. Dome Rooflight with Manufacturer's Curb

A dome or pyramid with integral upstand manufactured to standard sizes, but can also be purpose made to suit existing opening roof sizes. Other upstand heights can be supplied to accommodate various depths of roof insulation. Ventilator options not shown.

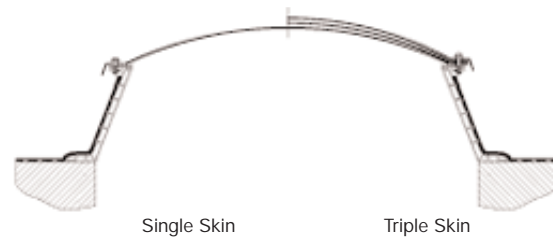

6c. Dome Rooflight with Manufacturer's Adaptor Curb

A dome or pyramid with integral adaptor curb usually manufactured to suit existing upstands. Ventilator options not shown.

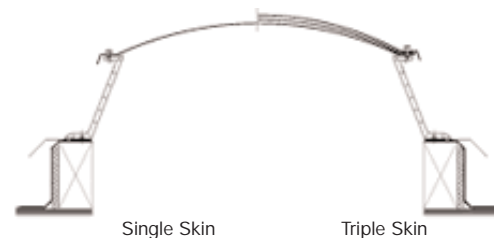

6d. Barrel Vault Rooflight

A low profile or semi circular barrel vaulted rooflight in solid or multi-wall, double or triple skin format and normally manufactured to suit specified dimensions. Can be supplied to suit builders upstand or with other upstand heights to accommodate various depths of roof insulation. Ventilator options not shown.

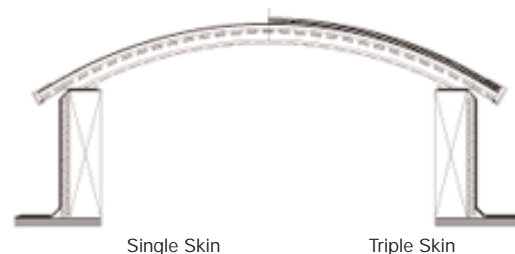

Rooflight Configuration

The factors to consider when designing the rooflight configuration are :

- a) Is there sufficient general lighting to create a pleasant and suitable internal environment?
- b) Is there a requirement for increased or controlled light levels in specific areas of the building e.g. play area in a sports hall?
- c) The relationship between the height of the building and the diffusing quality of the rooflights to provide good general light at ground level.
- d) Degree of roof maintenance and roof access envisaged.
- e) Weatherability and minimising laps, especially between dissimilar materials. There are a number of possible configurations for the rooflights.

7. Chequerboard Rooflights

This allows for individual rooflight units, both in plane and out of plane, and provides the most uniform distribution of light. The rooflight is fixed to the metal cladding or roof deck on all four sides and is therefore well supported.

This design has the maximum number of end laps or flashings and therefore requires the maximum attention to the sealing details by the roofing contractor with resultant increased costs.

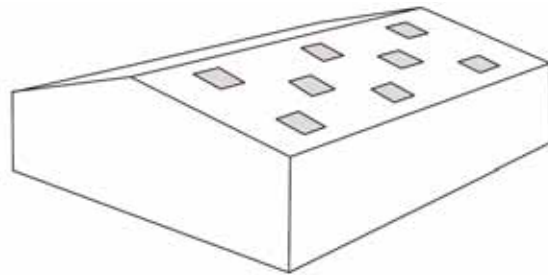

8. Ridge Lights - Barrel Vault Rooflights

Using a barrel vault rooflight along the ridge can provide an aesthetically pleasing design and a relatively uniform distribution of light only if the roof slope is short. The major advantage over the chequerboard arrangement is that they reduce the number of metal/translucent junctions to be fixed and sealed. However, at the ridge they are subject to high wind loads. Since it is recommended that rooflights should not be walked on at any time, where roof access is expected and frequent, ridge lighting provides a safer option.

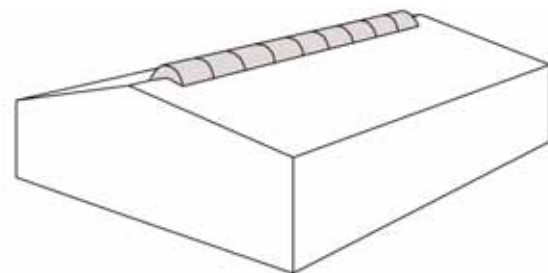

9. Ridge to Eaves - In Plane or Barrel Rooflights

Both profiled and barrel rooflights can be fixed from ridge to eaves or from ridge downslope. They minimise the number of metal/translucent junctions and could eliminate rooflight end laps, thereby improving reliability and servicing. However, since the rooflight industry does not recommend walking on rooflights at any time, a ridge to eaves layout will limit access across the roof.

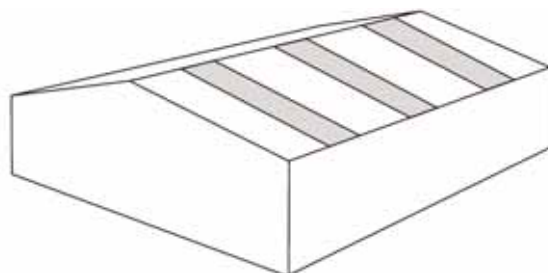

10. Mid Slope Rooflights

This configuration is only possible with rooflights which match the roof profile. It provides a compromise between chequerboard and ridge to eaves in terms of light distribution and buildability. It avoids all areas with high wind uplift and allows general roof access if the metal roof is suitable for walking on. This design is now very popular on new build work.

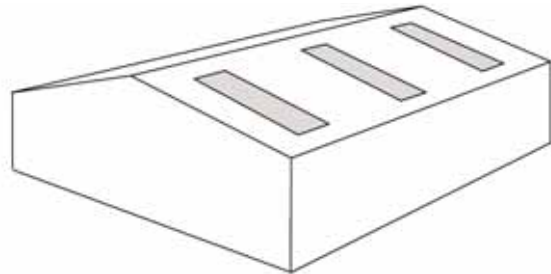

11. Continuous Run - In Plane Rooflights

Good levels of lighting achieved but less used on modern design. Care needs to be given to manufacturing and fitting tolerances of the metal sheets and rooflights to avoid a build up of tolerance difference. Replacing old reinforced glass fixed in T bars with modern profiled rooflights or panel systems is common practice and very effective.

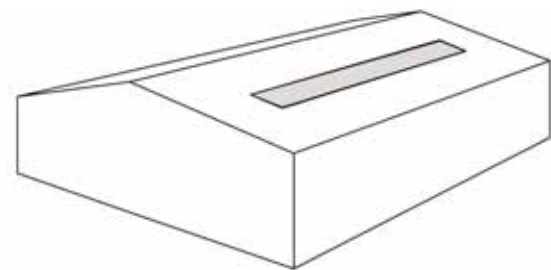

12. North Lights - In Plane Rooflights

This configuration could be viewed as a continuous run as above but is not subject to tolerance difference between metal sheets and rooflights. North lights on new build is no longer common practice but refurbishment with modern rooflights or panel systems is easily achieved.

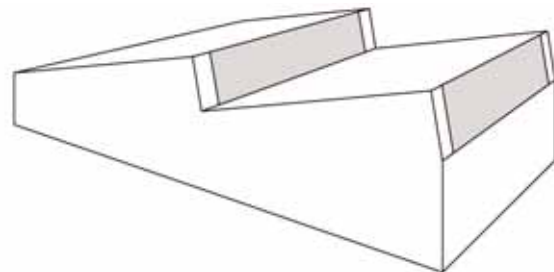

13. Random Design on Flat Roofs - Barrel and Dome Rooflights

Used on flat or low pitch roofs, the rooflights are placed according to need and roof design on purpose designed upstands

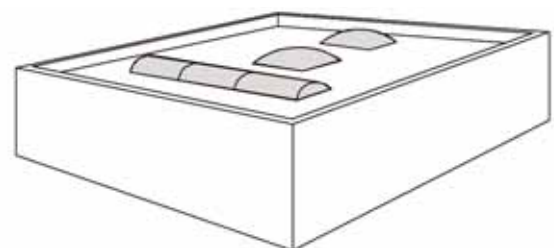

14. Curved Roof - Barrel Vault Rooflights

Placed on an upstand that curves to the roof, barrel vault rooflights can be applied to run over the crown of the roof and stopping either mid slope or down to the eaves. Ideal for metal standing seam system roofs and single ply membranes.

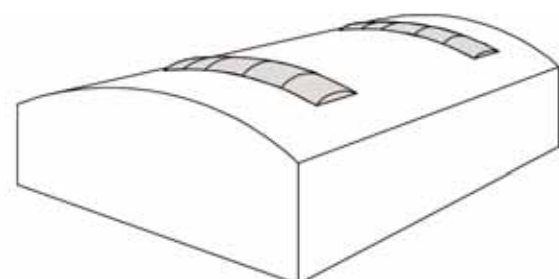

15. Structural Glazing

Bespoke structures of almost any shape and design, normally constructed from aluminium or steel sections and glazed with polycarbonate or glass units of varying specifications. These custom built structures are generally detailed by the rooflight manufacturer to an architects brief and allow immense freedom of design.

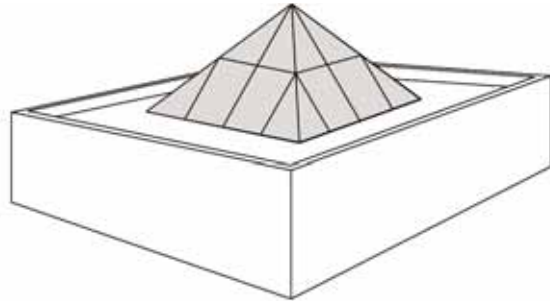

Material Types

Rooflight materials must allow light through, satisfy all durability, thermal, safety and fire requirements, and work with the roof covering material and/or the glazing system being used. The main rooflight materials in the UK are GRP, polycarbonate and glass, and to a far lesser extent PVC.

GRP

GRP remains the most versatile and commonly used profiled glazing material. Available to match virtually any metal or fibre cement sheet profile and ideal for barrel vault design. GRP offers excellent performance properties and provides high levels of diffused light into the building. In most industrial, sporting and commercial situations diffused light, which minimises glare and distracting shadows, is preferable. GRP sheets are produced in almost all profiles, and modern high quality GRP sheets incorporate UV absorbing surface protection which can virtually eliminate long term discolouration. In a very budget conscious world GRP is a very cost effective rooflight material.

Polycarbonate

Polycarbonate is a versatile material used extensively as a rooflight glazing. It has three sheet forms

- Solid - Flat or Domed
- Profiled
- Multiwall

The key properties of polycarbonate are common to all forms - exceptional impact resistance, high levels of light transmission, good workability and good fire rating. All are commonly available in clear and tinted options, with clear and most tints providing direct light, while clear patterned and opal tint provides diffused light and gives a soft quality to the light. Co-extruded UV protection eliminates up to 99% of UV radiation, protecting materials and people beneath it. Each form also has its own particular characteristics and properties.

Solid polycarbonate offers good optical clarity and superb workability. It can be cold curved on site, is suitable for use with a variety of glazing bar systems and can be moulded into various shapes such as domes and pyramids.

Profiled polycarbonate matches profiled roof cladding and allows the sky above to be seen through a corrugated material, a feature popular with many designers. It has very good profile accuracy and is available in a growing profile range. Extrusion and vacuum forming techniques allow a huge variety of profiles to be produced.

Multiwall polycarbonate is an insulating glazing material. Thicker sheets with more walls achieve the highest thermal performance, typically 1.6W/m²K for a 25mm five wall sheet. Structured polycarbonate is

most commonly used in most domestic and many commercial conservatories. Like solid polycarbonate it can be cold curved on site, although to a much lesser degree, it can be used in a variety of glazing bar systems, and has a very high strength to weight ratio making it ideal for the creation of glazing features.

Safety Glass

Most visibly used as roof glazing in large shopping centres but used widely in the more up market commercial sector and significantly in traditional pitched roofs. Flat glazed rooflights in typical flat roof applications are currently very fashionable.

Glass has excellent fire properties, good impact performance, very high light transmission and provides the mark against which the optical clarity of all other glazing media is commonly compared. It is widely acknowledged as having a very long life expectancy with no discolouration from UV degradation, and laminated versions provide a good level of reduction in UV transmittance. Glass can also be curved for use in barrel vault rooflights and supplied with various coatings, interlayers and surface treatments to provide coloured or textured surfaces to achieve obscure or diffused glazing, solar control and total UV protection to areas beneath the glazing.

PVC

PVC was used for industrial rooflight applications in the 1970s and 1980s, but has poorer impact resistance and weathering performance than other alternatives. PVC will not meet the non-fragility requirements without the addition of extra safety measures in the rooflight construction. It is now used very rarely in industrial or commercial applications, although it is a very popular DIY material. It is not expensive, has a reasonable strength to weight ratio and is straight forward to work with, thereby deserving its success as a DIY material for small, lowrise domestic projects.

Comparison Chart

Material	GRP	Polycarb'te Flat	Polycarb'te Multi Wall	Safety Glass	PVC
Transparency	Medium	Excellent	Medium	Excellent	Excellent
Untinted Translucency	Excellent	Good	Good	Medium	Medium
Strength	Excellent	Excellent	Excellent	Medium	Poor
Fire Rating	Class 0,1,3,4	Class 0,1,(Y)	Class 0,1,(Y)	Class 0,1	Class 1,(Y)
UV Resistance	Good	Good	Good	Excellent	Medium
Temperature Resistance	Excellent	Good	Good	Good	Medium
Thermal Insulation	Good	Good	Excellent	Good	Good
Sound Insulation	Good	Good	Medium	Excellent	Good
Rigidity	Excellent	Good	Excellent	Excellent	Good
Patterns	No	Yes	No	Yes	No
Colours	Yes	Yes	Yes	Yes	Yes
Cold Curving	Good	Excellent	Good	No	Good
Formability	No	Excellent	No	No	Excellent

Legal Requirements – Thermal Performance

Introduction

Full Guidance on the use of rooflights to help meet the requirements of Part L Building Regulations is given in NARM document “Designing with Rooflights: Supporting the Guidance in AD L2A & L2B (2006)”, which is a second tier document referenced from Approved Document L, and approved by the Department for Communities and Local Government. The following section provides basic information, the above document provides more comprehensive data and may be downloaded from the NARM website: www.narm.org.uk

The Building (Scotland) Regulations 2004, Section 6: Energy, Non-Domestic, has similar requirements to AD L2A and L2B. In this document all general comments and any specific reference to Part L will equally apply to Section 6 unless indicated otherwise. Paragraph references are specific to Part L unless otherwise stated.

The Building Regulations Part L 2006, designed to save energy and power consumption in buildings, is part of an on going legislative programme by the Government with long term building stock that will generate an ever decreasing release of carbon dioxide (CO₂) into the atmosphere.

Previous Part L legislation has concentrated on the fabric and assembly detailing of the building. Part L 2006 considers the energy used by all the systems required to operate the building, including:

- Heating
- Cooling
- Artificial lighting
- Domestic hot water

It continues to consider the fabric and assembly details of the building, which obviously impact on the energy use of the heating and other systems, but also considers the type and efficiency of the various building services to establish the total energy needed to operate the building, which is considered in terms of the CO₂ emitted to the atmosphere whilst generating this energy. This has become known as the building’s “carbon footprint”.

The interaction of building fabric and services requires a fundamental rethink to the design parameters of buildings. A good example of this is the consideration of rooflights to buildings. To allow daylight to pass through the rooflights, they cannot be filled with opaque insulating materials and thus rooflight areas are less insulated than the opaque area of the roof. In the past this has meant that reducing the rooflight area would improve the insulation quality of the building. Such decisions did not consider the impact of turning on the electric light to replace the reduced or lost natural daylight. The current legislation considers not only the energy impact of designing with rooflights to provide natural daylight but weighs this energy cost against the energy cost of providing artificial electric lighting.

Energy compliance to Part L 2006 is achieved with approved software such as the Simplified Building Energy Model (SBEM) that can be obtained from the DCLG. The computer program will consider the data for the complete building. Every piece of data will have a relevance to the energy consumption of the building and have an effect on whether or not the building (based on that defined in the Part L 2002 regulations) will be compliant. To comply, a stated reduction in CO₂ emissions, when compared to a Notional Building (based on that defined in the Part L 2002 regulations) must be achieved. In the case of rooflights, the Notional Building includes 20% rooflight area.

AD L2A New Buildings Other Than Dwellings

Compliance with AD L2A would be demonstrated by meeting 5 separate criteria (see AD L2A para7)

- criterion 1: the calculated CO₂ emissions must meet a defined target
- criterion 2: the performance of the building fabric (and systems) must meet design limits - see page 19
- criterion 3: there must be passive measures to limit solar gain - see page 21
- criterion 4: the as-built building must be consistent with the designed building (see AD L2A Paras 66-81)
- criterion 5: there is provision to operate the building in an energy efficient way (see AD L2A Paras 82-84)

The following information covers the effect of rooflights on the first 3 criteria. Rooflights have no specific effect on the latter 2 criteria, which are therefore outside the scope of this section.

Criterion 1: Calculated CO₂ emissions rate (see AD L2A paras 18- 32)

The calculated CO₂ emissions rate for the actual building (the building emission rate, BER) must not be greater than the target emission rate (TER). The TER is a given percentage improvement over the CO₂ emission rate of a notional building, calculated using the Simplified Building Energy Model (SBEM) or other approved software tool.

The notional building (defined in AD L2A para22) is the same size and shape as the actual building, but with fixed performance of both building fabric and services. Each element of the building fabric has the same performance as the notional building defined in Part L 2002 (Tables 1 & 2), which includes 20% rooflights, with a U-Value of 2.2 W/m²K.

The improvement required over the performance of the notional building (defined in AD L2A para 23) is typically 23.5% for naturally ventilated, or 28% for mechanically ventilated / air conditioned buildings, respectively.

The BER is the CO₂ emission rate (calculated using the same software tool as the TER) for the actual building.

Simplified Building Energy Model (SBEM) SBEM data entry – generic rooflight properties

Full details of how data for rooflights should be entered into SBEM is provided in the NARM guidance document referred to above.

The generic properties of the rooflights are selected by either:

- selecting an option from the standard SBEM library, which includes various rooflight types (e.g. in-plane, dome/pyramid, barrel vault, panel glazing and architectural skylights), each of which can be entered as single, double, triple or better insulated variants
- entering properties for the rooflight directly - the U-value, L-solar, and T-solar values

Note that single and double skin options should only be used where existing buildings are being analysed: for new build, or extensions, all rooflights should be triple skin or better to achieve a weighted average U-value of 2.2 W/m²K as shown in AD L2A Table 4. Criterion 2 (see page 19) sets detailed U-value requirements for Rooflights.

Data entered for out-of-plane rooflights must account for the effects of any glazing bars and kerbs.

SBEM data entry – specific rooflight details

Once generic details have been completed for any rooflight type(s) being used on the project, data for each individual rooflight application needs to be entered, including:

- the rooflight area (in each zone of the building)
- the surface area ratio (i.e. the ratio of rooflight area: daylight area which varies typically between 1.0 and 1.4 depending on rooflight type)
- the transmission factor, needs to be amended from the default value to 1.0 since this factor accounts for any shading (from overhangs etc) which doesn't apply to rooflights

It is critical that information for artificial lighting systems and lighting control systems is also entered correctly, since these are essential in order to achieve the reductions in CO₂ emissions, which can be offered by the correct use of natural daylighting.

SBEM results

SBEM generally shows that if rooflight area is reduced from the 20% area defined in the notional building, then overall CO₂ emissions increase: rooflight areas up to 20% minimize CO₂ emissions, give best SBEM results and help meet criterion 1 of AD L2A.

SBEM has been used to analyse two example buildings to demonstrate this:

- example 1: a large open span metal clad building, fitted with varying areas of in-plane rooflights
- example 2: the 'example building' used in the tutorial published with SBEM (with heating fuel altered to natural gas, to give a true reflection of heating requirement on CO₂ emissions). This building was modelled without rooflights (as shown in the tutorial) and then with varying areas of individual dome rooflights

Full details of both buildings are shown in Appendix 4 of the NARM guidance document.

The graphs in Figures 1-3 show the effects of altering rooflight area and rooflight U-value on overall CO₂ emissions, and also show CO₂ emissions due to heating and lighting requirements individually.

Figure 1 shows the overall CO₂ emissions when the first example building was modelled without rooflights, and with rooflight areas varying up to 20% (as assumed in the notional building) to demonstrate the effect

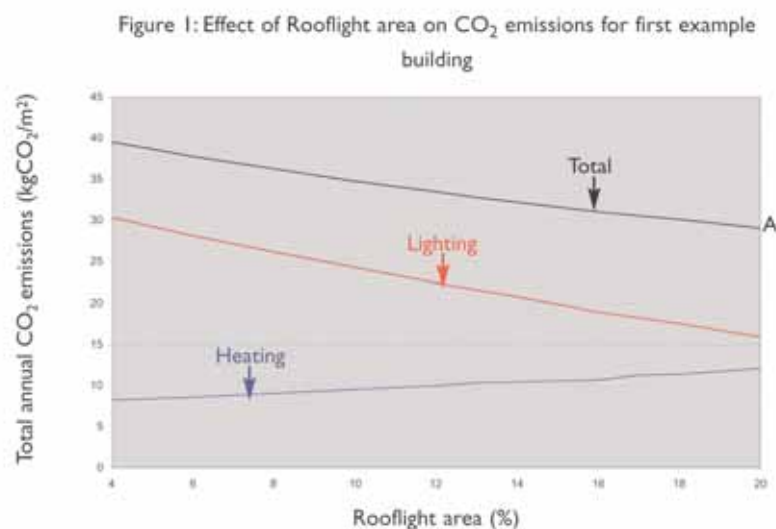

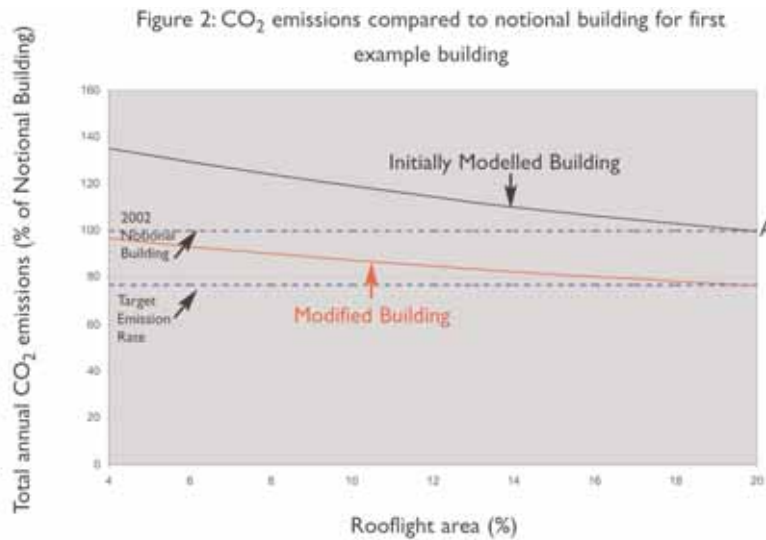

of varying the rooflight area. It also shows the SBEM calculation of energy used by heating and lighting systems separately (converted to CO₂ emissions using the conversion factors shown in AD L2A Table 2).

This graph clearly shows that rooflights offer a significant saving in overall CO₂ emissions, and thus make a major contribution towards meeting the target CO₂ savings of AD L2A. As rooflight area increases to 20%, overall CO₂ emissions continue to fall; in this example overall CO₂ emissions are 20% higher with 10% rooflights or over 35% higher without rooflights than they are with 20% rooflight area.

SBEM shows that, for this example, the CO₂ emissions for the notional building are 29.23kg CO₂/m² per annum (see Appendix 5); the overall CO₂ emissions shown in Figure 1 can also be expressed as a percentage of this figure, and are shown in this way in Figure 2, which also shows the performance of the notional building (100%) and the TER (23.5% saving). The building initially modelled (with 20% rooflight area, U-value 2.2W/m²K) has been modeled as closely as possible on a “2002 notional building”. The actual CO₂ emissions (BER) of this building, with 20% rooflight area (as in the 2002 notional building) are therefore equal to (100% of) the notional building. This is shown by point A on figures 1&2, whilst the black lines show the increase in CO₂ emissions if rooflight area is reduced, illustrating the same increase in CO₂ emissions (to over 135%) as rooflight area is decreased.

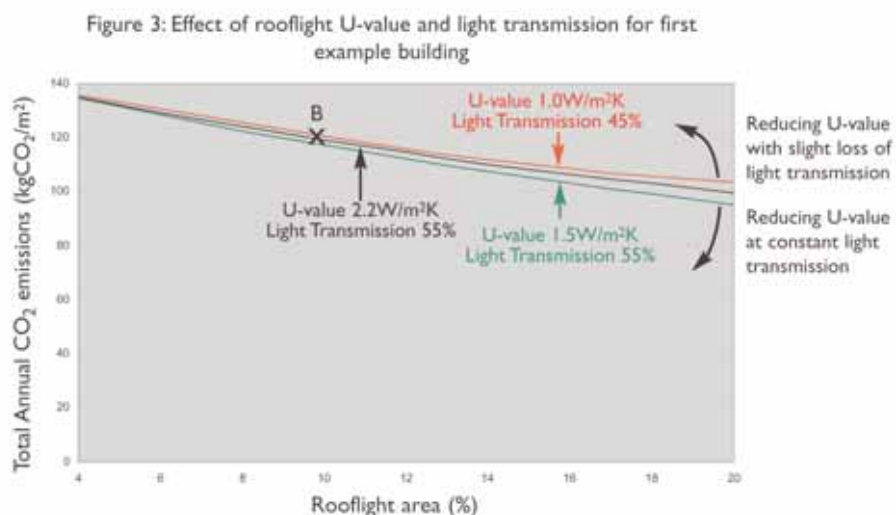

Buildings with improved performance

Significant improvement to the performance of the building would be required to achieve the TER (in this case, a saving of 23.5%). There are many ways of achieving this, such as improvements to lighting, heating and control systems, elemental U-values, air permeability, thermal bridging or use of renewable energy such as photovoltaics, solar energy systems, wind generators or solar walls.

The red line in Figure 2 shows results for an “improved” building where a selection of these improvements have been made, to achieve the TER of 76.5% when fitted with 20% rooflights.

These curves show the same trend as rooflight area is decreased for both the original and improved buildings: as rooflight area is decreased below 20%, so CO₂ emissions increase.

Whilst the target improvement set by AD L2A for a building with 20% rooflights may be 23.5% (i.e. a target of 76.5% of the notional building), if rooflights are omitted the starting point is more than 35% greater than the Notional Building and therefore an improvement of over 45% is required from this higher starting point. Similarly, if 10% rooflights are fitted, a 35% rather than 23.5% improvement would be required to achieve the TER.

Effect of U-value and light transmission

Better insulation of rooflights can offer further savings in CO₂ particularly at higher rooflight areas, as this can reduce energy use of the heating system, but this effect is secondary to factors which affect energy use of the lighting system - rooflight area and light transmission through the rooflight.

This is illustrated by Figure 3, which shows the effect of varying rooflight insulation value and light transmission. The black line shows an SBEM analysis with rooflights with a U-value of 2.2W/m²K (the minimum allowable insulation value as shown in AD L2A Table 4), and an overall light transmission of 55%; the green line shows analysis for the same building with rooflights with a significantly improved U-value of 1.5W/m²K (with unchanged light transmission).

This shows that in comparison to 10% rooflights with a U-value of 2.2W/m²K (point B on the black line), the following savings in CO₂ emissions can be achieved:

- 9% by increasing rooflight area to 15%
- 16% by increasing rooflight area to 20% (at 2.2 U-value)
- 1.5% by improving U-value to 1.5W/m²K (at 10% rooflight area)
- 20% by increasing rooflight area to 20% and improving U-value to 1.5W/m²K

An increase in rooflight area and an improvement in rooflight insulation can both offer a saving in CO₂ emissions - but it is much more effective to increase the area of rooflight with a given U-value than it is to increase the insulation of a rooflight at a given area.

Light transmission through the rooflight has a similar effect as rooflight area, since both parameters directly affect amount of light passing through the rooflight and hence energy use of the lighting system: light transmission through the rooflight is also more significant than U-value.

Care should therefore be exercised before focusing on rooflight U-values, since very well insulated (low U-value) rooflights often give slightly lower light transmission, which counters the effect of the lower U-value, reducing or even negating the expected saving in overall CO₂ emissions. For example, the red line in Figure 3 shows the SBEM analysis if rooflight U-value is reduced further (to 1.0W/m²K) but this is accompanied by a slight reduction in light transmission (to 45% overall) as is likely in practice. It shows the overall CO₂ emissions are higher than those achieved with rooflights with a U-value of 2.2 W/m²K and

light transmission of 55%: the small change in light transmission has a greater effect than the large improvement in rooflight insulation.

Second Example Building

Figure 4 shows results for the second example building; this is exactly as defined in the SBEM tutorial.

This building has been designed to significantly better standards than a 2002 notional building; even without rooflights, it achieved results where the BER was 69% of the notional building, thus achieving the TER of 72%.

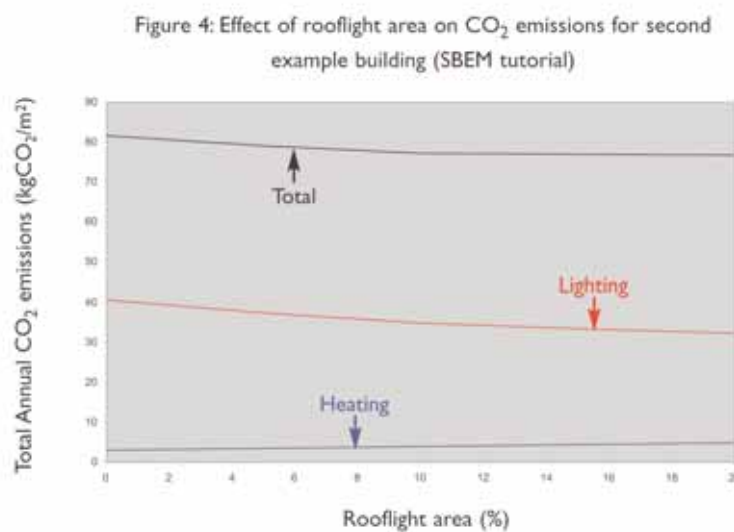

However, when rooflights were introduced, even in this multistorey building where they can obviously not have as great an impact, the contribution is still positive: overall CO₂ emissions without rooflights are 6.5% higher than when 20% rooflights are fitted. Separate checks are required to ensure Criterion 3 is also met: see page 21.

Summary of Criterion 1:

It is clear that in most building types, use of natural daylight in conjunction with well designed lighting and lighting control systems will reduce the energy consumption of artificial lighting systems. This will usually result in a reduction in the overall CO₂ emissions, helping achieve compliance with criterion 1 of AD L2A. This contribution is usually maximised by use of rooflight areas up to 20%. In many buildings the contribution of rooflights can be extremely significant – in the first example building, a building with no rooflights had overall CO₂ emissions over 35% higher than a building with 20% rooflight area.

Criterion 2: Limits on Design Flexibility (see AD L2A Paras 33-62)

Whilst achieving CO₂ emissions that comply with Criterion 1 allows considerable design flexibility, AD L2A also requires that reasonable provision should be made to limit heat gains and losses, and that energy efficient building services and controls be provided. The requirement on the building fabric would be met if the building complies with guidance in paragraphs 34-39, which cover insulation values of each element, and air permeability.

AD L2A Table 4 shows that the area-weighted average U-value of all the rooflights must not exceed 2.2W/m²K, whilst the U-value for any individual rooflight must not exceed 3.3W/m²K.

This means that where all the rooflights across a roof are the same, they must have a U-value of 2.2W/m²K or better to achieve the average U-value requirement shown in column (a) of Table 4.

Note that if the rooflights differ on a single roof, it would be acceptable for some rooflights to have insulation values as poor as 3.3W/m²K (as shown in column (b)), but the average (on an area weighted basis) must still be 2.2W/m²K. So if some rooflights were poorer insulated, others would have to be better, to keep the average constant. This flexibility is not relevant where all rooflights are the same.

AD L2A Table 4 Limiting U-value standards (W/m ² ·K) (extract)		
Element	(a) Area-weighted average	(b) For any individual element
Wall	0.35	0.70
Floor	0.25	0.70
Roof	0.25	0.35
Windows, rooflights and curtain walling	2.2	3.3

Comments to AD L2A Table 4

- The requirement of 2.2 W/m²K applies to the average insulation value of the entire rooflight after allowing for the effect of any glazing bars, kerbs or other thermal bridges
- This requirement will never be achieved by double skin plastic rooflights, but will usually be achieved by the use of triple skin rooflight assemblies
- Where a rooflight is constructed (in the factory or on site) using glazing bars, the effect of these glazing bars must be taken into account. Glazing bars that are truly thermally broken insulate better than the surrounding glazing material, and therefore have no detrimental effect on the insulating value of the rooflight. In other cases, the glazing bars may lead to some additional heat loss, which must be accounted for in the quoted U-value of the rooflight
- Out-of-plane rooflights are generally mounted on a kerb or upstand, which may or may not be as well or better insulated than the glazing material, and the thermal effects of this kerb must also be taken into account. Where kerbs are supplied with the rooflight, they should be regarded as part of the rooflight, and the effect of the kerb should be included in the U-value that is quoted for the rooflight. Where they are existing or manufactured on site, they can either be regarded as part of the rooflight, or as part of the roof (in which case they should meet the requirements for the roof)

Buildings with high internal gains

There is a concession in para 38, which allows the average U-value for glazing to be relaxed from 2.2 to 2.7 W/m²K in buildings with high internal gains, such as manufacturing process generating a lot of heat; this is only permissible if it can be shown that this reduces overall CO₂ emissions. This means that if (and only if) it can be shown that overall CO₂ emissions are reduced if rooflight U-value is increased from 2.2 to maximum of 2.7 (with no other changes), for example by using SBEM, then the average insulation of the glazing can be reduced accordingly; the worst case value of 3.3W/m²K still applies.

Summary of Criterion 2

In practice, where all the rooflights on a roof are the same, the rooflights must be at least triple skin or contain an insulating core, since double skin rooflights will never be able to achieve the U-value requirement of 2.2W/m²K shown in column (a) of Table 4, nor the relaxed value of 2.7W/m²K shown in para 38.

Criterion 3: Solar Overheating

Whilst correctly managed solar gain is a benefit, which can reduce heating requirements, it is a requirement of AD L2A that solar gain is limited, to avoid excessive internal temperature rise in summer. This would be achieved if the combined solar gain and other internal gains do not exceed 35 W/m². * The other primary internal gains in most buildings are typically occupants, artificial lighting and internal processes.

The other internal gains of a building define the maximum solar gain to ensure the sum total does not exceed 35 W/m². Research from De Montfort University has predicted the solar gain inside buildings for various rooflight areas, so the results can be used to equate the maximum allowable solar gain (which depends on other internal gains) to actual rooflight area. The results in the table show the solar gains and associated rooflight areas for different levels of internal gain, which ensure the combined gains do not exceed 35 W/m², thus complying with the regulations and avoiding solar overheating.

Internal Gain (W/m ²)	Maximum Solar Gain (W/m ²)	Equivalent Rooflight (%)
0	35	21
5	30	18
10	25	15
15	20	12
20	15	10

Any large plant or process facility may produce significant local heat gain (which can be in excess of the total limit of 35 W/m²). Where this is envisaged, localised heat extraction or cooling should be used to prevent overheating.

Internal gains due to artificial lighting

Internal gains due to lighting can be significant (for example, up to 15-20 W/m² in retail outlets), and could potentially present problems if artificial lighting was used in conjunction with rooflight areas over 10-12% at times of maximum solar gain.

However, the period of highest solar gain is simultaneous with the highest daylight illuminance; provided rooflight area is sufficient, the internal gains due to artificial lighting can be greatly reduced or eliminated by switching off the lights. Where this is done automatically (eg by photoelectric controls) the internal gain from artificial lighting would only be present when there is little daylight illuminance and hence little solar gain, so that it would seem reasonable to disregard the internal gain from artificial lighting when considering rooflight area.

AD L2A (para 63) states "specifying efficient lighting with effective controls will reduce internal gains that will also help to reduce internal temperature rise in summer when daylight availability is at a maximum".

Internal gains due to occupants

The final internal gain to consider is from occupants of the building, which depends highly on occupant density. Typically, in large industrial or storage facilities occupant densities are very low and the internal gain is almost insignificant and can be ignored, so rooflight areas up to 21% will not cause overheating. Practical experience in such buildings confirms this is reasonable.

Where occupant density reaches one person per 30m² (e.g. large retail stores), internal gains may reach around 5W/m² (since 1 person produces approx 140W seated or 160W light standing work or walking, rising to 265W when carrying out medium bench work), at this occupant density and level of internal gain, the table above shows rooflight areas up to 18% will not cause overheating.

Where occupant densities increase further (eg offices, classrooms etc), internal gains should be checked carefully against the table to determine the appropriate rooflight area.

In very densely occupied environments (e.g. call centres) internal gains due to occupants and equipment can be very high (up to 30W/m²). This is approaching the total acceptable internal gain, which would be exceeded if all other gains are as low as 5W/m², thus severely limiting the area of rooflight that is practical without use of mechanical cooling.

Direct radiant heat

It should also be noted that the quoted rooflight areas assume evenly distributed light from the rooflight. This depends on a degree of light diffusion from the rooflights, appropriate to the height between roof and ceiling, and the rooflight layout/distribution: the lower the ceiling, or less evenly spread the rooflights, the greater the level of diffusion required.

If rooflights are clear or do not provide sufficient diffusion then the direct radiant heat through the rooflights can produce localised overheating directly beneath the rooflights, regardless of rooflight area, in the same way as can occur adjacent to a window.

This can be resolved by using a rooflight layout that gives as even a spread of light as possible, in conjunction with an appropriate level of diffusion provided by the rooflight.

Summary of Criterion 3:

Rooflights generate some solar gain which is usually a benefit, reducing heating requirements and CO₂ emissions.

Rooflight areas up to 20% will not generally cause overheating, except where other internal gains are unusually high.

AD L2A (para 63) states: "When considering the proportion of glazing in a building, the designer should give consideration to the provision of adequate levels for daylight".

** see CIBSE TM37 "Design for Improved Solar Shading Control", 2006*

AD L2B Work on Existing Buildings that are not Dwellings

This section is designed to assist the user to understand the Guidance in AD L2B in respect of the use and application of rooflighting to repairs, refurbishment and extensions to existing buildings.

Definitions of Note

- Thermal Element is defined in Section 5 AD L2B Para 109. The Roof is a Thermal Element and does not include the rooflights
- Rooflights are Controlled Fittings and treated separately from Thermal Elements

Controlled Fittings

Rooflights are Controlled Fittings and where replacement, refurbishment or building extensions are required that involve rooflights, then they should be no worse than the U-values detailed in AD L2B Table 5– Standards for Controlled Fittings W/m²K

Comments to AD L2B Table 5

- The U-value requirement for “plastic” rooflights is 2.2W/m²K
- The requirement of 2.2 W/m²K applies to the average insulation value of the entire rooflight after allowing for the effect of any glazing bars, kerbs or other thermal bridges
- This requirement will never be achieved by double skin plastic rooflights, but will usually be achieved by the use of triple skin rooflight assemblies
- This requirement applies in all cases, including:
 - Rooflights in extensions
 - Replacement rooflights in existing roofs
 - New rooflights in refurbished roofs
- “Plastic” rooflights refers to all rooflights, except those glazed with glass. These will generally be Glass Reinforced Polyester (GRP) or Polycarbonate. Alternative plastics may be available but are not generally specified in the UK market, as they do not usually meet non-fragility and/or fire performance requirements
- Where a rooflight is constructed (in the factory or on site) using glazing bars, the effect of these glazing bars must be taken into account. Glazing bars that are truly thermally broken insulate better than the surrounding glazing material, and therefore have no detrimental effect on the insulating value of the rooflight. In other cases, the glazing bars may lead to some additional heat loss, which must be accounted for in the quoted U-value of the rooflight
- Out-of-plane rooflights are generally mounted on a kerb or upstand, which may or may not be as well or better insulated than the glazing material, and the thermal effects of this kerb must also be taken into account. Where kerbs are supplied with the rooflight, they should be regarded as part of the rooflight, and the effect of the kerb should be included in the U-value that is quoted for the rooflight. Where they are existing or manufactured on site, they can either be regarded as part of the rooflight, or as part of the roof (in which case they should meet the requirements for the roof)
- Appendix 3 shows how the area weighted average U-value is calculated to allow for the effects of the kerb, this method is also appropriate here.

AD L2B Table 5 Standards for controlled fittings (W/m ² ·K) (extract AD L2B 2006)		
Fitting	(a) Standard for new fittings in extensions	(b) Standard for replacement fittings in an existing building
Windows, roof windows and glazed rooflights	1.8 for the whole unit OR 1.2 centre pane	2.2 for the whole unit OR 1.2 centre pane
Alternative option for windows in buildings that are essentially domestic in character, a window energy rating of	Band D	Band E
Plastic rooflights*	2.2	2.2

Buildings with high internal gains

There is a concession in para 77, which allows the average U-value for glazing to be relaxed from 2.2 to 2.7 W/m²K in buildings with high internal gains, such as manufacturing process generating a lot of heat; this is only permissible if it can be shown that this reduces overall CO₂ emissions. This means that if (and only if) it can be shown that overall CO₂ emissions are reduced if rooflight U-value is increased from

2.2 to a maximum of 2.7 (with no other changes), for example by using SBEM, then the average insulation of the glazing can be reduced accordingly; the worst case value of 3.3W/m²K still applies.

Extensions under AD L2B

- Large extensions that are greater than 100m² and (note not “or”) greater than 25% of the floor area of the existing building are to be regarded as new buildings and guidance AD L2A will apply
- Conservatories less than 30m² are exempt from Building Regs and do not apply to this section
- For existing buildings that exceed 1000m² floor area, an extension will trigger Consequential Improvements to the original building
- Applies to enclosing existing structures such as covering over a courtyard

Rooflight design for Building Extensions

Extensions that fall under the requirements of AD L2B will be compliant if built to the Elemental Method and subject to given design constraints. In respect of rooflights, reasonable provision will be if:

(1) the rooflight U-values are 2.2 W/m²K or better as shown in AD L2B Table 5 (page 10) and paras 26 and 75

(2) areas are limited as detailed in AD L2B Table 2 (below) and para 27

It is to be noted that for all extension types, the rooflight area is limited to 20% of the floor area. However, also note in Para 27, that where the existing building has in excess of 20% rooflight area, a reasonable provision for the extension will be to have a rooflight area which is limited to the same % of roof area as the original building to which the extension is attached.

Extensions with Optional Approach with more design flexibility

Paragraph 29 of AD L2B allows for more design flexibility by varying U-values, on a constant area weighted U-value basis, if opening areas vary from those shown in AD L2B Table 2 (below). However, the average U-value for each element may not be any worse than shown in column (a) of AD L2B Table 3 (below).

This means the average U-value of all the rooflights on a building must still be 2.2W/m²K or better, so no reduction in rooflight insulation value is permitted if rooflight area is reduced (thus removing the “trade-off” in rooflight U-values which was permitted under 2002 regulations).

Column (b) of AD L2B Table 3 shows that an individual rooflight(s) may be permitted to have poorer insulation value (max U-value 3.3 W/m²K). However, the area weighted average must still achieve 2.2W/m²K, so if some rooflights are poorer insulated, others must achieve higher performance to achieve

AD L2B Table 2 Opening areas in the extension (extract)		
Building type	Windows and personnel doors as % of exposed wall	Rooflights as % of area of roof
Residential buildings where people temporarily or permanently reside	30	20
Places of assembly, offices and shops	40	20
Industrial and storage buildings	15	20
Smoke vents	N/A	As required

L2B Table 3 Limiting U-value standards (W/m ² K)		
Element	a. Area weighted average U-value	b. Limiting U-value
Wall	0.35	0.70
Floor	0.25	0.70
Roof	0.25	0.35
Windows, roof windows, rooflights and doors	2.2	3.3

the necessary average. This is only likely to apply if, for example, there are different types of rooflights within a roof where some may not be able to achieve a U-value of 2.2W/m²K.

Reducing rooflight area will increase energy use of artificial lighting systems; the research from De Montfort University and results from SBEM show that reduction in rooflight area will generally increase consumption of energy, and emissions of CO₂, as well as losing the widely recognized benefits of a naturally lit interior, and will thus increase the carbon footprint of the extension.

This point is emphasised in AD L2B para 29 which states “In industrial buildings, rooflights are a beneficial source of daylight, and so significant reductions in rooflight area could result in increased use of electric lighting”.

Great care should therefore be exercised if rooflight area is reduced significantly from the 20% area shown in AD L2B Table 2, in this type of building.

Work on Controlled Fittings – Replacement and Refurbishment

AD L2B (para 75) covers requirements wherever a controlled fitting is being replaced. If rooflights need replacing, for whatever reason, then compliance will be achieved by following Column (b) in AD L2B Table 5 shown above.

There is no requirement that where one or a number of rooflights are to be replaced, then all the rooflights should be replaced. The only requirement is that those that are replaced meet the new standards as set out above.

Consequential Improvements

Where an existing building has a floor area over 1000m², and work is to be carried out on the building by way of an extension, or initial provision or capacity increase of any fixed building services, then a requirement for “consequential improvement” to the building to improve the energy performance of the original building is triggered, to a value of 10% of the main project works.

Consequential improvement is only required if both technically and economically feasible, the latter defined by a simple payback of 15 years.

The NARM guidance document provides 8 practical solutions that are listed on Page 14 to upgrade the original building that is shown in AD L2B Table 1 – Improvements that in ordinary circumstances are practical and economically feasible. Item 7 identifies “Replacing existing windows, roof windows or rooflights or doors which have a U-value worse than 3.3 W/m²K”. This is saying that an acceptable step to compliance to achieve consequential improvement is to replace old rooflights that have U-values greater than 3.3 with new rooflights that have U-value of 2.2 W/m²K

Since there will be a basic requirement to upgrade the original building in line with the financial limits stated, there will be considerable advantage to selecting Item 7 as one of the improvements costs since –

- There will be considerable thermal efficiency savings by replacing old rooflights at a U-value of 5.7 W/m²K to new rooflights at a value of 2.2W/m²K
- The old rooflights may have lost a large part of their light transmitting qualities – new rooflights will put daylight back into the building to make it a more pleasant place to work
- The additional daylight will mean the electric lights can be switched off creating further considerable energy savings
- The new rooflights may be specified to be non-fragile making the roof a safer place should maintenance staff need to access the roof

Legal Requirements – Non-Fragility and CDM

When specifying rooflights, designers should consider carefully the potential to eliminate or reduce known or predictable hazards. The decision on how best to specify rooflights should take account of the risks associated with temporary gaps during construction, and the risks when access to the roof is needed later e.g. during maintenance or cleaning.

As in all building work good safety standards are essential to prevent accidents. In accordance with the Health and Safety at Work Act and the Construction (Design and Management) or CDM regulations 2007, the building should now be designed with safety in mind, not only for the construction period but throughout the normal life of the building. This must include considering the safety of people involved in maintenance and repair, and even demolition. It might mean providing permanent access to the roof, walkways and parapets, for example. The HSE document HSG 33 Safety in Roof Work refers specifically to fragile rooflights as an example of a potential hazard to be considered and to be avoided as far as possible.

Construction of the roof is one of the most hazardous operations because of the potential for falls or material dropping onto people below. The roofing contractor must plan and document a safe system of work before starting construction. This must take into account if any of the roof assembly will be fragile until fully fixed. Metal roofing systems together with appropriate rooflights, even after the first fix of lining out, can be designed to be non-fragile. However until the systems are fully fixed, both metal and rooflights must be regarded as fragile.

Where specifying rooflights designers should consider the following options :

- Specifying in plane rooflights that are non-fragile
- Fitting rooflights designed to project above the plane of the roof, and which cannot be walked on (these reduce the risk but they should still be capable of withstanding a person falling onto them)
- Protecting rooflight openings e.g. by means of mesh or grids fitted below the rooflight or between the layers of a built-up rooflight
- Specify rooflights with a design life which matches that of the roof, taking into account the likely deterioration due to ultraviolet exposure, environmental pollution, and the internal and external building environment

When properly fixed, most GRP and polycarbonate double skin in plane rooflights can be classified as non-fragile (usually Class B), using the industry accepted test procedure ACR[M]001:2005. (for more information refer to NARM Guidance Note:2006/1). All in plane units (even non-fragile) should be identifiable when installed, (for example by the use of poppy red fixing heads) to identify the rooflight location.

PVC, which is an inherently brittle material, always requires extra safety reinforcement. However, even non-fragile rooflights are likely to be damaged by impact; they are usually not intended to support foot traffic and crawling boards must be used at all times.

Out of plane rooflights (including modular rooflight units, barrel vault and patent glazing derivatives, etc.) should also be classified to the requirements of ACR[M]001:2005. Consideration should also be given to the requirements of prEN1873 using an energy rating of 1200 joules.

On completion of the building, designers should provide a Health and Safety File to the building owner. The following information should be included in respect of the roof and rooflights.

- No person should have access to the roof, unless under the direct supervision of a competent person who is to assess and take action to minimise risks.

-
- Access to the roof should be avoided when it is wet or in slippery conditions.
 - The rooflight specification, including the weight (thickness) of the rooflights, the non-fragile test method and classification when new, and the expected non-fragile life of the roof and rooflights.
 - A schedule for cleaning and maintenance for both performance and longevity of the specific rooflights.
 - Never walk on rooflights, irrespective of their non-fragility classification. Even rooflights that are designed to be non-fragile for the life of the roof could be damaged by foot traffic, and this may affect both the non-fragility performance and the light transmitting quality of the rooflight in the long term.

Legal Requirements – Fire Performance

Building Regulations Approved Document B (2006 edition amended 2007) sets out the rules for fire safety of buildings. Section B2 covers internal fire spread, and applies to the linings of both the roof and walls of buildings. In general these are surface spread of flame requirements to BS476 Part 7 (typically Class 1 and Class 3) or to BS EN 13501 Part 1 (typically Class C-s3, d2 or Class D-s3, d2). Section B4 covers external fire spread and applies to external coverings or roofs and walls; in general these are fire resistance requirements to BS476 Part 3 (typically AA and AB) or to BS EN 13501 Part 5 (typically BROOF (t4)).

Thermosetting materials (GRP) can be tested to BS476 Parts 3 and 7, and to BS EN 13823 and BS EN ISO 11925 Part 2 then classified to BS EN 13501 Part 1, and a variety of grades are usually available offering alternative fire ratings to meet the main requirements.

Thermoplastic materials cannot be tested to BS476 Part 3, as the material melts during the test. Building Regulations define an alternative classification method for these materials :

- Polycarbonate at least 3mm thick, PVC (any thickness), and multiwall polycarbonate, which is rated Class 1 to BS476 Part 7, are given the rating Tp(a)
- Other thermoplastic materials can be tested to BS2782, and given ratings of Tp(a) or Tp(b)
- Polycarbonate or PVC which achieve Class 1 when tested to BS476 Part 7 or Class C-s3, d2 when tested to BS EN 13501 Part 1, can also be regarded as having AA or BROOF (t4) designation

For the majority of industrial buildings, the requirements can be summarised as follows:

- The lining of a roof or wall should normally be rated Class 1 to BS476 Part 7, Class C-s3, d2 to BS EN 13501 Part 1 or Tp(a)
- A concession allows the lining to be rated Class 3 to BS476 Part 7, Class D-s3, d2 to BS EN 13501 Part 1 or Tp(b) if the area of each rooflight is less than 5m², and there is a clear space of 1.8 metres in all directions between each rooflight
- There are no restrictions on use of roof outer sheets rated at least AC to BS476 Part 3 or BROOF (t4) to BS EN 13501 Part 5. Rooflights with outer skin fire ratings less than this should not be used within 6 metres of a boundary
- A single skin sheet must meet the requirements for both the inner ceiling and outer roof surface
- The only requirement for greater protection of wall outer sheets is where the building is within 1 metre of a boundary or is over 20 metres tall or is a building to which the public have access, when some areas will require sheets rated Class 0 or Class B-s3, d2 to BS EN 13501 Part 1

Assembly and Accessories

In Plane Rooflights

Fixings

The mechanical properties of plastic rooflights differ from metal and fibre cement sheets. They are more flexible and can have a lower fastener pull through value (i.e. Suction loadings which pull the rooflights over their fasteners). The pull through performance values of fastener assemblies should be determined in accordance with Annex B: BS5427: Part 1: 1996.

Fasteners are required to be watertight and to restrain the rooflights without damage when subjected to wind loads determined in accordance with BS6399: Part 2: 1997 – Code of Practice for Wind Loads, and support the design snow loadings described in BS6399: Part 3: 1988 – Code of Practice for Imposed Roof Loads. When required, rooflight manufacturers can provide guidance for calculating wind and snow loads covered by the above Code of Practices. Load calculations outside the scope of the above documents should be provided by a structural designer.

Assembled rooflights are also required to meet the HSE non-fragility requirements as detailed in Section 5. The number of fixings, the size of washer, purlin centres and location of fixings will have a bearing on the non-fragile performance of the rooflights.

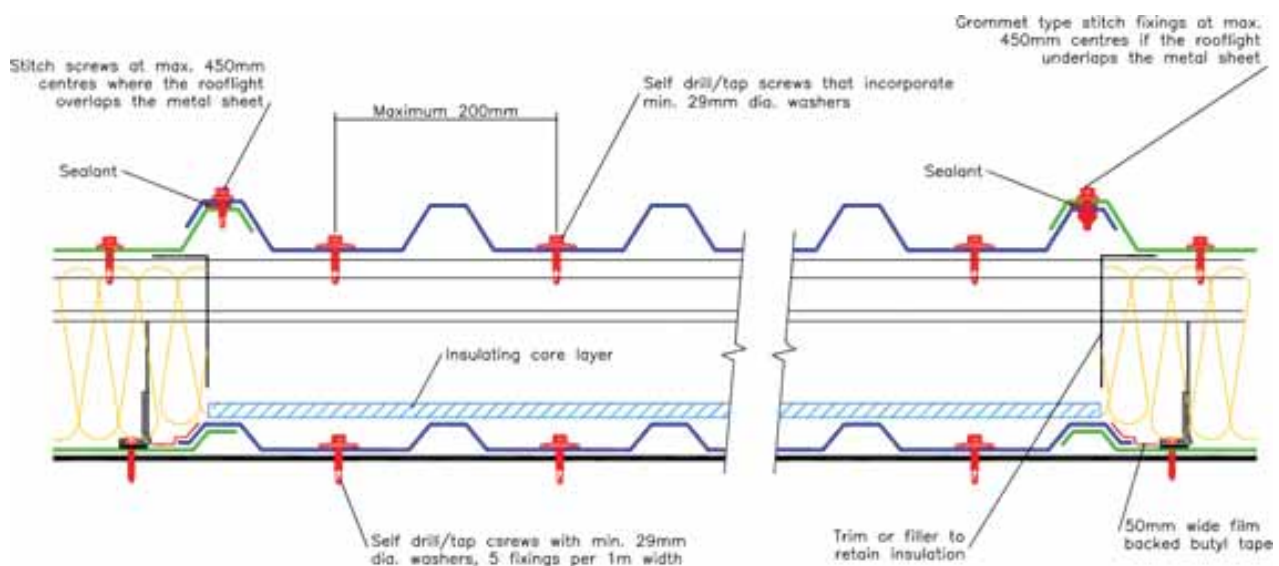

Figure 1 – In Plane Site Assembled – Cross Section

To meet the above design loadings and the non-fragility requirements, washers of at least 29mm diameter should be used in conjunction with 5.5mm diameter primary fasteners. The preferred location of the fasteners is usually in the bottom flat troughs of profiles (see below), except for continuous sinusoidal profiles which have no flat area where crown fixings should be employed. To prevent build up of rainwater behind the fasteners, the washer diameters should be at least 10mm less than the trough width. Wide troughs may require more than one fixing in each trough.

When sheets are fixed through the crown of the corrugation, rigid profile, shaped supports are required between rooflights and supporting members to enable the fasteners to be correctly tightened without distorting the profile.

Roof purlins must have a level face parallel to the roof plane, otherwise if twisted the rooflight liners will deform.

NB: With the new Thermal Performance Regulations, the additional weight of insulation and accessories may be an issue regarding roof purlin design.

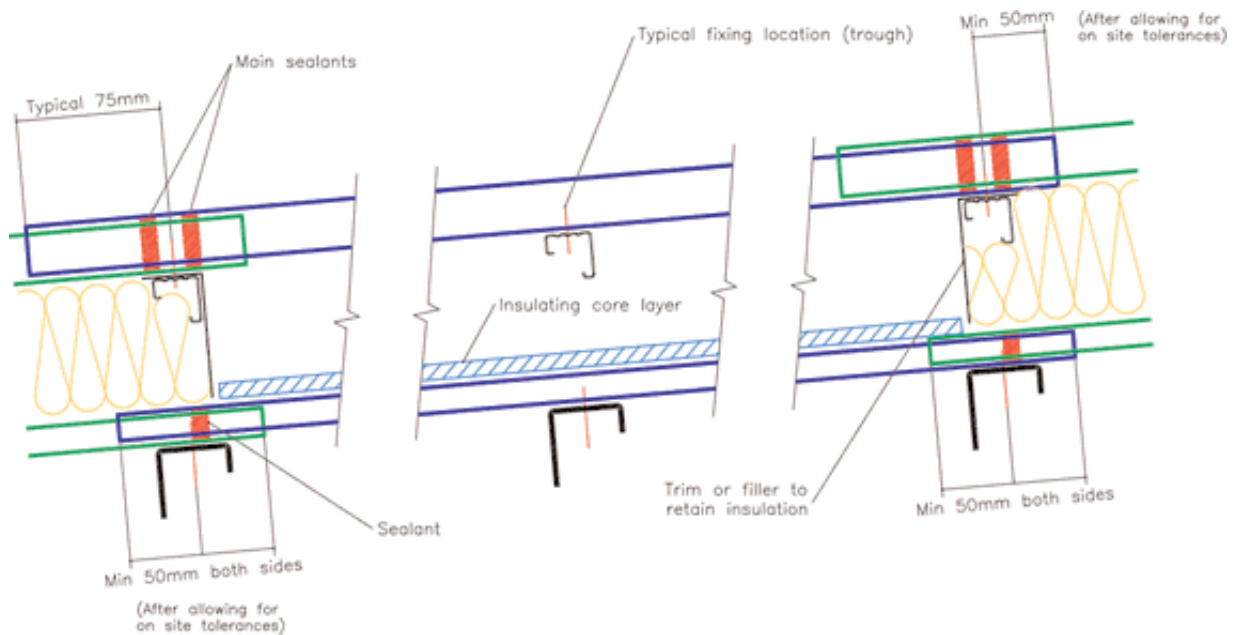

Figure 2 – In Plane Site Assembled – Longitudinal Section

Where buildings are in non-exposed locations, less than 10 metres high, and have limited permeability, wind loading is usually less than 1.2kN/m² in general roof areas. GRP rooflights in 32mm deep trapizoidal profiles of weight 1.83kg/m² and 2.44kg/m² can be used at purlin centres of 1.8 metres and 2.0 metres. Similarly profiled polycarbonate rooflights of thickness 1.2mm can be used at purlin centres of 1.5 metres. In all cases the rooflight should be fixed at all purlins with 29mm diameter washers on fasteners, and a minimum of five fasteners across the sheet width. Heavier or thicker rooflights, or reduced purlin centres will be required when rooflights are located in areas of high local suction wind loading adjacent to roof verges and ridge.

Provided that rooflights, located in the general roof area, are installed to meet the design wind and impact loadings, they will support the snowloads likely to occur in the UK. When rooflights are used in zones where:

- exceptional high loadings may occur
- on high buildings
- adjacent to abutments
- where valleys abut parapet walls
- other obstructions where snow drifts are likely; then heavier weight rooflights will probably be needed.

Plastic rooflights are more flexible than metal and fibre cement sheets. Whilst this allows these sheets to deflect to a greater extent without damage the following criteria should be adhered to:

- Limit wind load deflection to 1/15th span or up to 100mm total deflection, to prevent excessive wear around the fasteners.
- Snow loadings should not deflect the rooflights to more than 1/15th span or never more than 50mm, to avoid disruption of sealants which may cause end laps to birdmouth.

On built up site assembled rooflights, it is recommended that the liners and the top sheet assembly is fitted progressively across the roof. If lining out only, contractors must be fully aware of CDM non-fragility requirements for both rooflights and opaque sheets. To prevent any distortion of liners, always fix progressively from one end. Do not secure each end prior to fixing at intermediate purlins.

Stitch side laps at centres not exceeding 450mm. On exposed sites and roof pitches below 10°, reduce centres to 300mm. Stitch rooflight to rooflight with roofing bolts or proprietary fasteners, which provide adequate support on the undersides. Where rooflights overlap metal sheets, self tap screw fasteners may be used.

When drilling for side lap fasteners, where the rooflight underlaps care must be taken not to push down the underlap with the drill. When the drill bursts through the outer sheet, the drill should be lifted to allow the liner to recover and then continue drilling with care.

Primary fasteners should not be fixed within 50mm of the end of the rooflight, after allowing for on site tolerances, unless provision is made to reinforce the edge of the rooflight, (a typical example is the built up/end upstand on factory assembled units).

Where rooflights extend to the bottom of the downslope (e.g. at eaves or valley) the overhang should not exceed 150mm.

Due to high thermal expansion coefficient of PVC and polycarbonate rooflights, over sized holes are required around the primary fasteners to accommodate the thermal movement without stress. On such rooflights up to 3 metres long over size holes should be 10mm diameter. On sheets up to 4 metres long over size holes should be 12mm. Due to high thermal movement, the length of PVC and polycarbonate rooflights should not exceed 6 meters and at this length a very high standard of workmanship at installation is required.

GRP rooflights do not normally require any special provision to allow for the thermal movement.

Application

To comply with the statutory requirements discussed in the outlined in Section 4, rooflights used on insulated and heated buildings must be of triple skin or insulated construction. They may be assembled on site as a built up system or fabricated as a single component under factory conditions. Use site assembled rooflights with in situ insulated double skin roofing systems. Factory assembled rooflights are used in conjunction with composite panels or under purlin lining systems. Rooflights assembled on site consist of top sheets and liners to match the profiles of the adjacent opaque roofing systems with proprietary profiled sheets or other insulating layers installed between the top sheets and the liners. On factory manufactured insulating units, flat or profiled liners with upstands to form a box are bonded to the underside of the external sheet, with additional insulating components between the sheet skins.

Sealants

Seal end laps on external weather sheets with two runs of preformed sealants applied within 15mm on each side of the primary fasteners. Ensure that sealants are well bedded into the corrugations prior to the application of the overlapping sheets. When rooflights overlap rooflights or overlap metal, an additional seal close to the end of the lap will restrict dirt and moisture ingress.

Seal weather sheet side laps with at least one strip of preformed sealant tape located out board of the side lap stitchers (sealant laid in line with side lap fasteners can twist and become distorted when drilled through).

On built up assemblies, translucent liners form an integral part of the vapour sealed lining system. It is recommended that each side of the translucent liners should overlap the metal liners, and be sealed with 50mm wide film backed butyl tape applied over the joints between the translucent and metal liners. Seal end laps with a similar tape or a single run of sealant fixed above the fasteners.

Where the vertical upstands of factory assembled rooflights abut composite panels, they may be effectively sealed with closed cell, foam plastic strip.

Although adequate sealing will control moist air entering the rooflight in new build, some temporary misting may occur on the underside of the external sheet, particularly on cold, clear, frosty nights. This is normal and the misting will disappear as the structure dries out.

Polycarbonate rooflights should not come into contact with plasticisers, and barrier tape (not PVC) should be used to prevent contact with plastisol coatings on steel sheets.

Out of Plane Individual and Continuous Rooflights

Fixing Requirements and Weather Tightness

Figure 3

Fixing requirements vary slightly between rooflight manufacturers but the general curb/dome arrangement remains the same. However, the curb installer must follow the instructions supplied with each particular type of rooflight.

When using a preformed metal, plastic or GRP curb – Figure 3, this must be fixed squarely to the roof structure that surrounds the rooflight opening using appropriate fixings e.g. wood screws in the case of a timber structure.

An allowance will need to be made within the roof construction for the height of the roof insulation, in order that a 150mm clearance can be achieved from the top of the finished roof weatherings to the top of the rooflight curb. It is important to continue the roof weatherings to the top of the preformed curb, thus providing a continuous weathertight seal. Where vents are incorporated into the side of the curb, the clearance must be at least 150mm to the underside of the vents before a break in the weatherings.

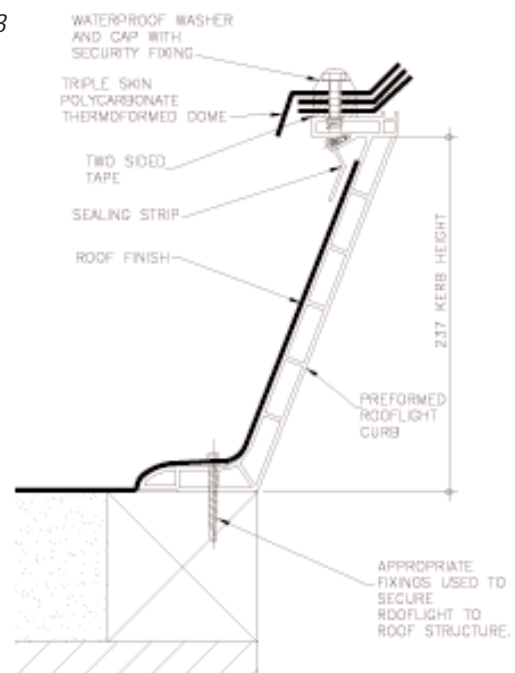

If no allowance is being made within the roof construction for the thickness of the roof insulation, an extra high preformed curb should be specified as necessary in order to maintain the 150mm minimum installation of the dome above the roof surface.

When domes are supplied complete with preformed curbs, the fixing holes in the domes are normally pre-drilled. Should it be necessary to drill fixing holes, these must be oversized to allow for thermal movement.

Care should be taken when bonding torch applied membranes and flashings to a preformed curb, and this should be completed prior to the installation of the dome. Many single ply membranes can be cold bonded to the preformed upstand, therefore, is possible to apply these following installation of the dome.

Prior to fitting the dome, it is important to fit a sealing strip around the entire perimeter of the fixing flange and fixing washers must be compressed onto dome, again maintaining a weather tight seal.

Many intermediate sections are available for fitting between the preformed curb and dome, such as ventilators, access hatches and smoke vents. These are normally factory fitted to the preformed curb, however, should site assembly be necessary, the installer must follow the particular manufacturers instructions.

Where a dome is to be installed directly to a builders timber curb – Figure 4, an allowance must be made within the roof construction in order that a 150mm clearance is maintained between roof weatherings and the top of the finished curb. It is advisable to continue the flashings over the top edge of the curb.

Many intermediate adaptor sections, vents, etc., are available for installation between the builders timber curb and dome, and these should be fixed in accordance with the manufacturers instructions.

The sealing strip, which must be continuous, is applied to the top of the builders curb prior to the installation of the dome, which will normally allow for overlap of the flashings assuming the curb is level and fixed squarely.

Barrel vault rooflights are available in all rooflight materials to suit standing seam systems, secret fix systems, flat and curved roofs. There are numerous designs which employ different methods of construction although all types are normally fixed to a curb support structure or similar.

The manufacturers fixing and sealing recommendations must be followed to ensure that weather tightness, impact resistance, durability and insulation requirements are maintained.

Fig.5 illustrates a typical cross section of a barrel vault rooflight. These are available in a range of widths to match the system that the rooflights are used with. Barrel vault rooflights can provide varying lengths and widths as required.

Figure 4

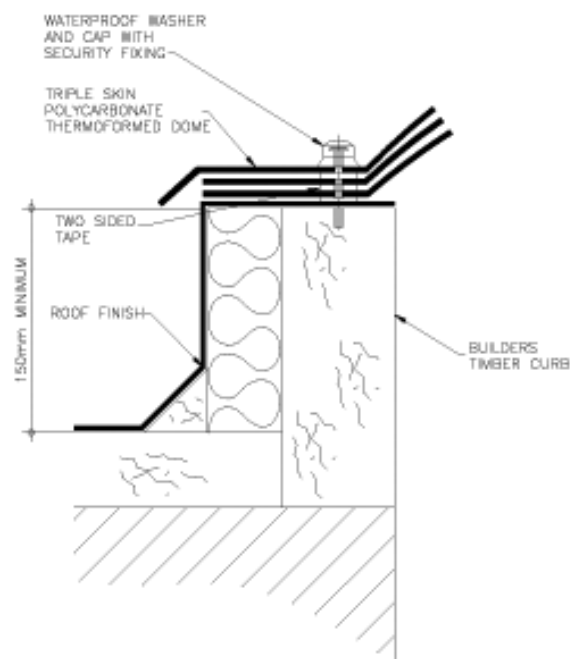
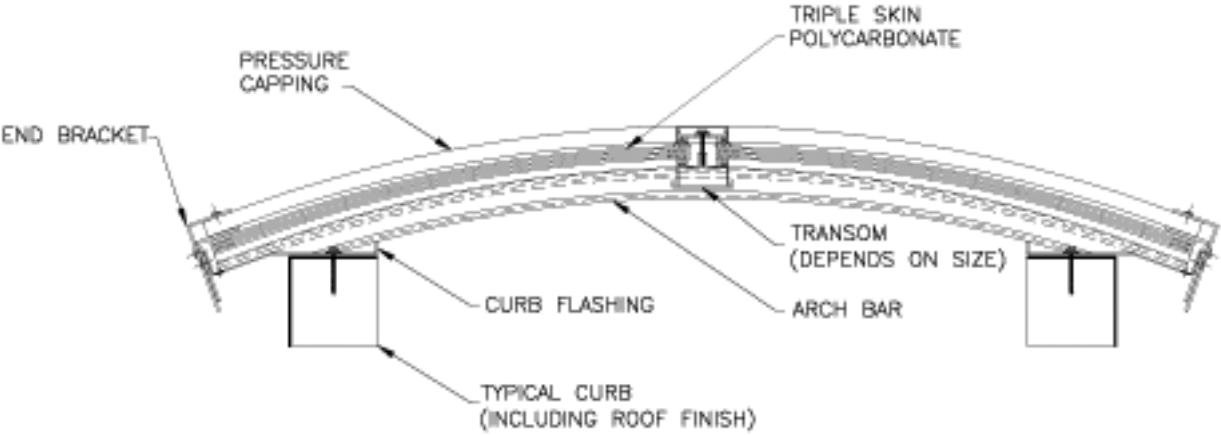

Figure 5 – Barrel Vault Rooflight – Cross Section



Durability

Durability is the ability of a building and its parts to perform its required function over a period of time (BS7543). Virtually all materials will change physically when subject to UV radiation, moisture and atmospheric pollution. This change may well affect both their performance and appearance. The designer must therefore ensure that, not only will the materials and details used be suitable initially, but also that they will have a satisfactory life if the necessary maintenance requirements are met.

Materials

When considering in plane rooflights, the materials selected for both the roof cladding and rooflight can have a significant effect on the durability of the rooflights, and the amount of maintenance that will be necessary during their life. Components that are exposed to the weather and sunlight are particularly important.

The type of rooflight materials and roof sheeting colour must both be considered. Generally light coloured roof sheets are preferable because they do not absorb as much sunlight as dark colours, and they are therefore cooler. This means they will have less effect on the rooflight laps, which tend to deteriorate more quickly at higher temperatures. Similarly light coloured seals and fillers should always be used. This is particularly important with thermoplastic rooflights, and generally it is not an issue for GRP thermosets. Lighter roof sheet colours also have the best life and they optimise the thermal performance of the roof. The performance might also depend on the shape and orientation of the building and the environment.

Out of plane rooflights are generally unaffected by the surrounding and adjacent materials being isolated from them by the upstands, curbs and isolating systems. They are however, similarly subject to the same rules regarding fillers, seals and other components. Normally however, the rooflight will be delivered in a condition such that it can be incorporated directly into the roof assembly.

All rooflights are subject to gradual deterioration that will cause fading, discolouration and embrittlement, with some PVC being particularly susceptible. Plastic rooflights are generally resistant to normal pollution in the atmosphere, provided the products have been protected with UV light inhibitors, and suitable surface protection.

With the use of special coatings and films the products can be used in aggressive chemical environments. Resistance to discoloration, surface degradation and embrittlement depends, to a large extent, on the surface protective treatment used by the manufacturer.

GRP

Most GRP rooflights will remain structurally sound for 30 years or longer. UV light and weathering could cause discolouration and surface erosion (thinning), but does not cause embrittlement or weakening of the sheets. Long term performance depends on environment, quality of sheets and surface protection, and maintenance. Discolouration of unprotected sheets can begin within 5 years, but good quality sheets incorporating UV absorbing surface protection (as supplied by all NARM members) will usually prevent significant discolouration for at least 20 years with the right maintenance program, and can virtually eliminate UV discolouration throughout their life. Higher fire resistant sheeting discolours more quickly when exposed to UV light due to the effect of the fire retardant additives.

Polycarbonate

The current generation of polycarbonate rooflighting products are manufactured from high quality extruded sheet material. With these materials, not only is there a high level of basic UV inhibitor but also co-extruded protective layer on both faces of the sheet. This is known as enhanced UV protection and always carries a manufacturers warranty. Additionally, the sheet manufacturer often warrants the performance of the material, even after thermo-forming.

Polycarbonate rooflights can be expected to be fit for the purpose, in excess of 15 years, with a slow (but documented) deterioration of light transmission and strength. Some enhanced UV protected high performance polycarbonate products have a life of 15 – 20 years. As with many high performance materials, care must be exercised with regard to compatibility with adjacent materials. Some roofing sheet finishes (for example plastisol coated steel) can, over time, affect the mechanical performance of the product and an appropriate isolating system should be applied.

PVC

Most PVC darkens and embrittles under UV radiation providing a useful life of 5-10 years. Specially formulated and protected grades are available and, if properly fixed, can last over 20 years. PVC, especially in cold conditions, should always be treated as a fragile material and should therefore not be used on industrial/commercial buildings, unless additional means are provided in the design to prevent falls through the rooflight.

Fasteners

In Plane Rooflights

For all rooflights stainless steel fasteners should be used. Stainless steel fasteners must also be used when fixing to aluminium sheets, to prevent bi-metallic corrosion. The durability of the fixings will affect the non-fragile status of the rooflights, and care must be taken to ensure the fixings' durability is compatible with the specified or stated non-fragile life of the roof and rooflights. Fixings with integral plastic heads are more reliable than push on caps, and the use of poppy red heads for rooflight fasteners is recommended.

Modular and Vaulted Rooflights

Always use stainless steel fixings, grade A2 to BS6105, with the fixing type being chosen to suit the supporting substrates.

Design Details for In Plane Rooflights

Rooflights must be assembled correctly in order to achieve the maximum durability. Avoiding water and dirt traps, by ensuring satisfactory slopes and end laps, is particularly important with in plane systems.

The frequency of fixings and the size of the washers, needed for rooflights and rooflight liners, will generally be different to that of the surrounding metal sheets.

Rooflights will also require side lap stitching. A full fixing specification must be obtained from the rooflight manufacturer to ensure long term durability and non-fragility.

Design Details for Out of Plane Rooflights

Generally these rooflights are delivered in a format such that they can be incorporated directly into the roof construction. If site assembly is required, the component parts are prefabricated from suitable materials.

Maintenance

The durability of any rooflight, regardless of the material from which it is made, is always dependent on regular maintenance. Maintenance regimes vary from manufacturer to manufacturer, and each should be approached for their specific recommendations according to their warranty, but in general terms, the requirements can be described as follows:

Cleaning

Clean regularly to maintain the highest levels of light transmission, usually every 12 months. As well as affecting light transmission, surface contamination can affect the heat absorption of many glazing materials, and this in turn can affect the long term physical and optical properties.

The cleaning process is generally uncomplicated, consisting of washing down with warm water and mild detergent. Abrasive, caustic and chemical treatments are unnecessary, and may actually cause damage to the exposed surfaces of the rooflight. A soft cloth or brush may be used to remove persistent contamination. In the case of paint or bitumen splashes, white spirit or alcohol applied with a soft cloth may be used with care. A final rinse with clean water will complete the process. Pressure hoses should not be used as the high pressure water can penetrate the sealing systems.

Inspection

Rooflights should be inspected at least once a year. This is often best combined with a cleaning process. The surface of the rooflights should be checked for damage, and any found should be repaired in accordance with the manufacturers' instructions. Any damage which penetrates the surface protection of the units will, in time, affect the ability of the unit to resist impact, and with the advent of non-fragile systems, this is particularly important.

Finally, all fixings should be checked for tightness and corrosion. Many non-fragile systems rely on the security of the fixings to achieve their impact performance potential. Any fixing found to be inadequate should be replaced.

Every second or third inspection should include a check of the sealing systems, replacing any that are showing signs of failure.

Note:

Obviously, the frequency of inspection and maintenance must be tailored to suit the local environment conditions on the roof in question, with higher levels of aggressive atmospheres requiring shorter inspection periods.

General

Although rooflight degradation can be minimised by careful specification, attention to detail during construction, inspection/repair and frequent cleaning, the rooflights are only likely to provide adequate daylighting for 20 to 25 years. Replacement must be anticipated during the life of the building. More detailed information can be obtained from individual manufacturers.

Long Term Non-Fragility

Provided rooflight products are fixed in accordance with the manufacturers recommendations, rooflights manufactured by NARM members will be designed and produced to be non-fragile when installed, unless stated to the contrary. As with most other roof cladding materials, it must not be assumed that the non-fragility status will last the life of the building.

Good quality GRP rooflights have a service life in excess of 25 years, and polycarbonate 15 - 20 years. However, resistance to impact relies heavily on the quality of the installation, such as method and condition of the fixings, and any deterioration of 'external' aspects of the installation can jeopardise the non-fragility classification of the rooflight assembly, even when there is no deterioration of the rooflight itself.

It is likely that most rooflights will remain non-fragile for between 5 and 20 years, but the exact time at which an assembly will become fragile cannot be determined.

For good quality GRP in-plane rooflights as supplied by NARM members, it is possible to increase the weight of the rooflight sheets, increasing the margin of safety sufficiently so that typical deterioration of an assembly will not jeopardise the non-fragility classification, so that it can be expected that non-fragility will be retained for 25 years, although this should not be guaranteed.

Detailed recommendations on the minimum weights of GRP rooflights which are required to ensure non-fragility when new, and the increases in sheet weights for expected 25 year non-fragility, are given in Tables 1 and 2 of NARM Guidance Note 2006/1. This document also explains in detail durability of good quality GRP sheets, factors which can affect non-fragility, maintenance requirements, and other conditions in order for the recommendations to be valid (for example, for expected 25 year non-fragility all fasteners should be stainless steel). Note that these recommendations cannot be assumed to apply to products not supplied by NARM members.

There are much stronger and safer rooflight options available which may retain their non-fragility classifications for longer periods. The designers, in line with their design responsibility, should determine the risks, the required life and period of non-fragility, and the extra margins to include in order to maintain longer term safety.

Siteworks

Transport

Rooflights may be supplied loose, shrink wrapped, on pallets or crated to comply with customers requirements.

Sheet lengths up to 8m can generally be supplied but lengths in excess of 12m will require special transportation and special consideration on manpower and/or crane off loading facilities. It is normal practice for sheet unloading to be the responsibility of the contractor/client, and specific off loading requirements must be notified to the manufacturer/supplier prior to despatch.

Storage on Site

Where possible store the rooflights indoors in cool dry conditions, avoiding direct sunlight. If outdoor storage is unavoidable, store in secure locations where the rooflights are unlikely to be stolen, damaged by site vehicles or foot traffic.

Stack in plane rooflights on clean level battens at least 100mm wide. Curved barrel vault lights will require additional supports to prevent them spreading. Locate supports at 1.5m for GRP and 1.0m for thermoplastics, and limit stack heights for GRP to 1.5m and for thermoplastics to 1.0m.

If the sun's radiation, even on dull days, is allowed to pass unchecked through the layers of unprotected rooflight sheets, the pack of sheets could become a solar battery, where the infrared radiation is entrapped creating a continuous build up of heat. Any moisture entrapped between the sheets will then boil and the resulting vapour, now at high pressure, will discolour the sheets. Additionally, for the thermoplastic rooflights permanent sheet deformation could take place.

To prevent this problem, always protect the sheet stack with reflective opaque waterproof covers draped over timbers to avoid direct contact with the rooflights and allow air circulation round the stack. Secure the covers to prevent wind damage and water penetration.

Particularly in wet conditions, frequently check to ensure that water has not penetrated the stack.

Note:

These comments are particularly relevant when sheet stacks are loaded out on to a pitched roof. Without full cover protection, the upslope sheet ends are very vulnerable to driving rain entering the pack of sheets, with capillary and gravity taking the water to the centre of the stack.

Handling

Caution must be exercised when handling and installing rooflights in windy weather. Rooflights are frequently large, relatively lightweight, and when caught in gusting wind will endanger the personnel handling them and any person nearby.

When handling single skin rooflights they should be supported at 3 metre centres. Long length single sheets may be carried by rolling the sheets across their width to form a cylinder and roped at 1.5 metre intervals. Ensure that the down turn on the exposed sheet edge faces downwards to prevent ropes from snagging on the sheet edges.

When carrying multi skin factory assembled or barrel vault rooflights, care must be taken not to twist them. They should be carried at all time by two men, as illustrated, or more in the case of long units.

Always wear protective leather gloves to avoid cuts from sharp edges of sheets.

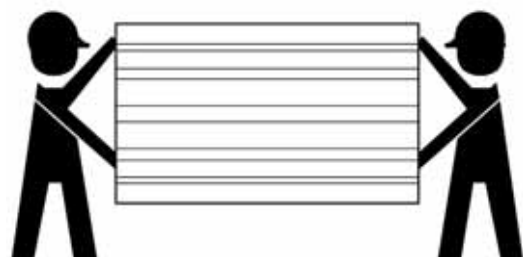

Cutting and Drilling

Cut rooflights with a power saw having a 40/60 grit diamond blade operating at minimum speed. Alternatively, they can be cut with a hacksaw having 6 to 8 teeth per centimetre held at a shallow oblique angle.

Holes must never be punched through rooflights as this can cause cracking around the holes. This reduces the pull through performance of the fasteners (i.e. the force required to pull the rooflight over the fastener when subject to suction loadings).

Use standard metal drills for drilling GRP. Drill thermoplastics with masonry type drills, or metal drill bits having a point angle of 130°. To accommodate thermal movement in thermoplastic rooflights, the diameter of the holes where the primary fasteners are to be fixed, must be at least 10mm diameter.

COSHH Regulations

For GRP, polycarbonate and PVC when cutting or machining with power tools, a non-toxic biological inert dust is produced. These dust levels should be kept as low as reasonably practical, and must not exceed the Occupational Exposure Limit of 10mg/m³ – 8 hour TWA value.

When working outdoors, it is most unlikely that these levels could be reached. When working indoors or in confined areas, adequate ventilation should be provided. When extensive operations are necessary, suitable dust extraction equipment should be used.

When cutting sheets, operators should always wear suitable dust masks and goggles to avoid any irritation in the nose, throat, lungs and eyes. In isolated cases, dust may cause slight transient irritation. Should these effects be prolonged or any sign of rash occur, medical advice must be obtained.

All exposed skin must be thoroughly and frequently washed with soap and water. Any eye contamination must be washed with copious amounts of clean water.

Sheet edges can be sharp, always wear gloves when handling sheets.

Do not smoke in or near stores or working areas.

Whilst the use of long length rooflights may reduce the number of end laps and reduce material costs, site conditions must be considered. A long length rooflight (exceeding 7 metres) is relatively light in weight, and when handled on high exposed buildings, can be awkward to handle even in mild blustery conditions.

In the event of a fire involving rooflight material, the safe extinguishers to use are:

- Carbon Dioxide
- Water
- Foam
- Dry Powder

Noxious fumes may be produced which can contain carbon monoxide, carbon dioxide and soot particles. Breathing equipment is advisable in enclosed areas.

Published by:



National Association of Rooflight Manufacturers

NARM Secretariat

43 Clare Croft

Middleton

Milton Keynes

MK10 9HD

Tel: +44 (0)1908 692325

Fax: +44 (0)1908 674122

Email: admin@narm.org.uk

www.narm.org.uk

Whilst the information in this publication is correct at the time of going to press, the National Association of Rooflight Manufacturers and its member companies cannot be held responsible for any errors or inaccuracies and, in particular, the specification for any application must be checked with the individual manufacturer concerned for a given installation.